

ZM-18B

Industry / Craft

Brand new product for a variety of applications

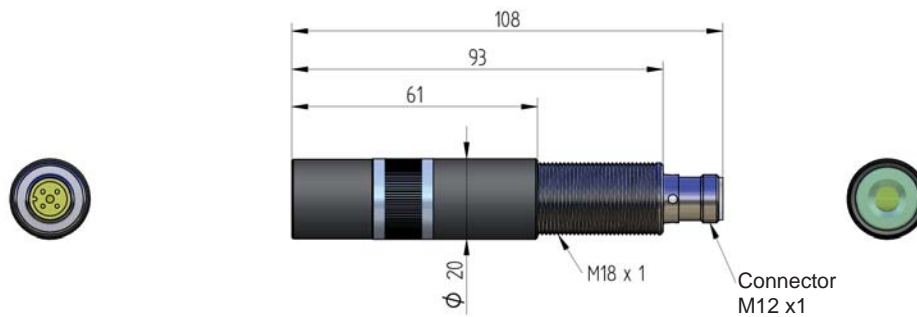

Features

- 5-30VDC operation
- Powers up to 200mW
- Red, infrared, laser wave lengths available
- Gaussian, uniform and DOE optics available
- Simple, external hand focusing mechanism
- IP67 rated, fully water proof
- Thread mounted for simple and versatile mounting
- LED laser operation indicator
- Over voltage protection with surge/spike protection
- Reverse polarity protection

Applications

- Positioning
- Wood processing
- Metal processing
- Textile industry
- Stone processing
- Food industry
- Medical science
- Automotive industry

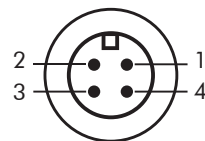

1: voltage supply +
2: -
3: voltage supply -
4: -

Some available Optics

Line

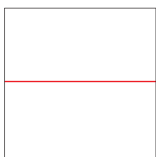

Cross

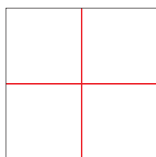

Parallel lines

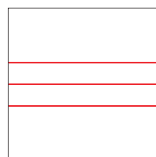

Dotted line



Dot matrix

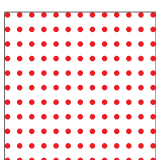

Square

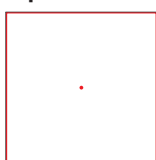

Circle

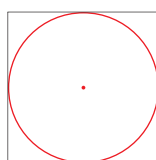

10 Circles

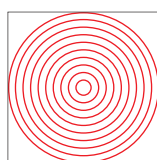

Mounting and power supply

H8-M18



WNG-9E-24



Specifications

Optical

Optical stability	0,15% / °C
Wavelength vs. temperature	Typ. 0,25nm / °C
Range of focus	100mm up to ∞
Divergence of beam	≤ 1mrad (with dot optic)
Pointing stability	< 15μrad / °C

Optics

Line (Gaussian profile)	60°, 90°, symmetrical or asymmetrical
Line (Non Gaussian profile)	10°, 20°, 30°, 45°, 60°,90°
Point	elliptical or circular
DOE	see examples on front side

Standard wavelengths and power (other on request)

635nm, 640nm, 643nm, 808nm, 980nm	up to 200mW depending on wavelengths
-----------------------------------	--------------------------------------

Electrical

Supply voltage	5-30VDC
Mode of operation	APC with current limiting or CC
Modulation	continous wave
Protection	reverse polarity and transient/ESD
Connection	M12 plug, 4-pin

Mechanical

Dimensions	108mm x Ø 20mm
Housing	Laser: M18 industry housing, chromed brass Optic head: anodised aluminium
Protection category	IP 67
Weight	ca. 70g
Electrical isolation	potential free housing

Environmental conditions

Case temperature (with Z-LASER mounting)	-10°C up to +50°C (with mounting H8-M18)
Storage temperature	-10°C up to +80°C
Humidity	Max. 90%, non condensing
MTTF at 25°C	> 30.000h (635 -980nm), > 100.000h (808 +980nm)

Order code:

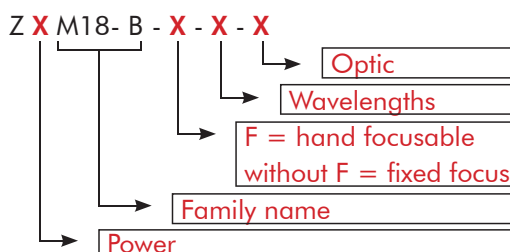

COMTRONIC

C/. Mur, 6 08760 - Martorell ☎ 937 750 750 Fax 937 754 426
<http://www.comtro.com> comtronic@comtro.com